

LL20.10^{MK2}



Working height / Arbeitshöhe	20,15 m
Outreach / Seitl. Reichweite	9,70 m
Weight / Gewicht	2.840 kg
Length / Länge	5,01 m
Width / Breite	0,795 m
Up & over / Up & over	8,20 m

Safe and performing

Favorable ratio between height, reach and stabilization area, useful for working at height in different sectors.

Sicher und leistungsstark







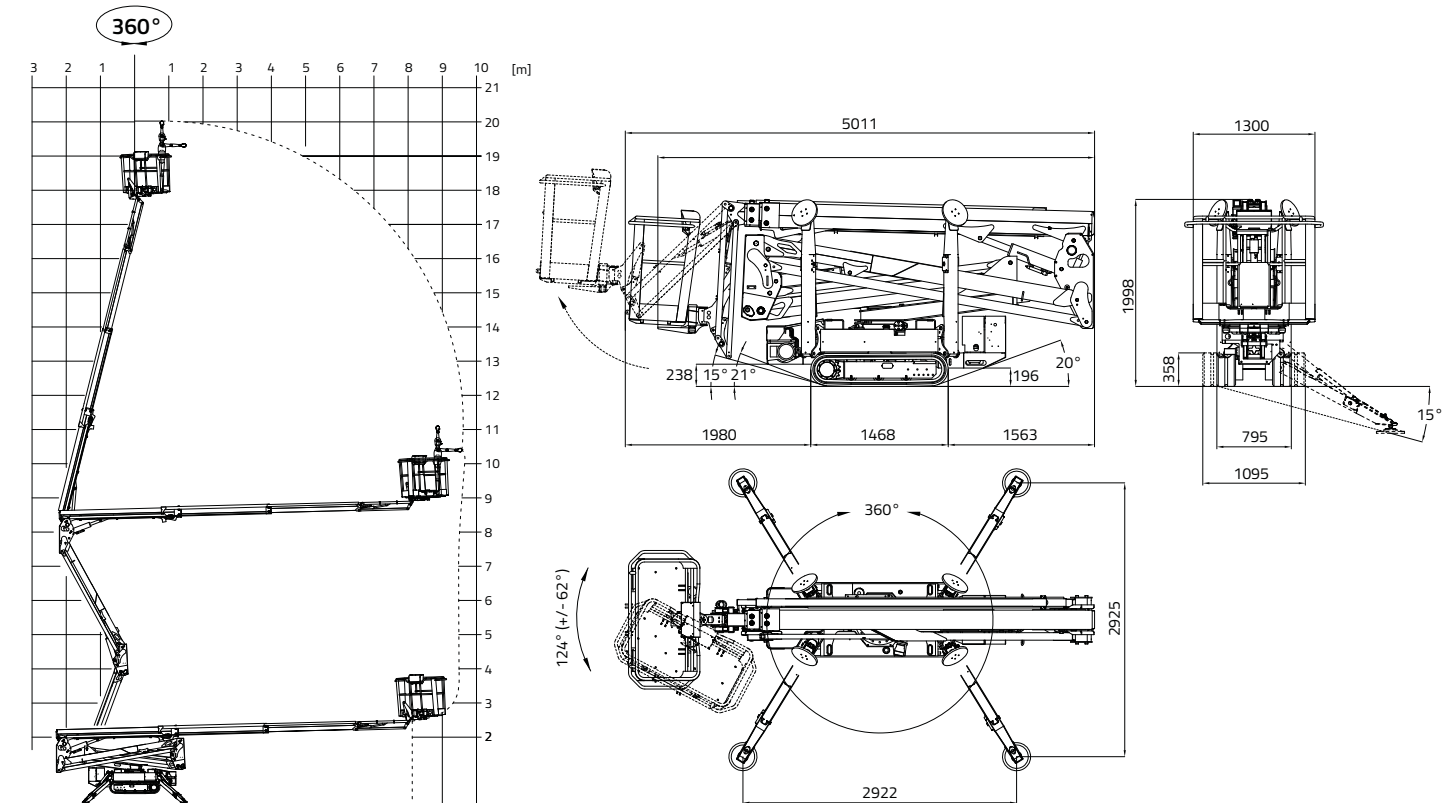











Vorteilhaftes Verhältnis zwischen Höhe, Reichweite und Abstützfläche, vorteilhaft für zahlreiche Bewegungen im Höhenbereich.

Capacity 230 kg 2 persons 80x2=160 kg + tool box 70 kg

Korblast 230 kg 2 Personen 80x2=160 kg + Werkzeugkasten 70 kg



100Ah/72V
Optional - Optional 

- | | | |
|--|---|--|
|  20,15 m |  16° / 28,7% |  2.922 x 2.925 mm |
|  9,70 m |  2.840 kg / 6.261 lb (Honda)
2.940 kg / 6.481 lb (Kubota)
2.950 kg / 6.503 lb (Lithium-ion) |  Automatic set up system III S std
III S – Abstütz- und Einfahrtomatik
serienmässig |
|  5,01 m |  ■ Honda iGX390 Automatic rpm control
11,7CV 3.600 rpm
■ Kubota Z602 Autorev system 14,5CV 3.200 rpm |  Remote control
Kabelfernbedienung |
|  4,39 m |  2,2kW-230V-50Hz
2,2kW-110V-50Hz |  GPRS-GPS |
|  1,99 m |  795 - 1.095 mm |  R.A.H.M. |
|  1.335 x 690 x h 1.100 mm |  0,4-1,0-1,95 Km/h (Honda)
0,5-1,3-2,5 Km/h (Kubota) | |
|  124° (+/-62°) |  2.150 daN - 3,04 daN/cm ² | |